

RAILSTOP RS S06

User Manual

RAILSTOP RS S06

Guided type fall arrester including a rigid anchorage line

Subject to technical changes

BRIEF DESCRIPTION

INTENDED USE

The guided type fall arrester including a rigid anchorage line RAILSTOP RS S06 is part of personal protective equipment (PPE) of category III to prevent falls from heights. The fall arrester RAILSTOP RS S06 in combination with a full body harness in compliance with DIN EN 361 with a fall arrester D-ring at chest height (sternal) and also a multifunctional D-ring at waist height, also called a ventral attachment D-ring, only serves to secure one person ascending or descending a ladder.

This equipment may only be used by persons familiar with personal fall prevention equipment and the risks associated with working in areas where there is a risk of falling.

The fall arrester RAILSTOP RS S06 may only be used in combination with the tested rail guide. It may only be used to secure persons and may not be used to transport loads.

The PPE may only be used vertically. The angle of inclination of the ladder may be max. 75° to 103.5°.

- Maximum number of users: 1 person per fall arrester
- Maximum user weight including clothing and equipment 140 kg
- Minimum user weight including clothing and equipment 50 kg
- Application temperature: -30 °C to +60 °C

All other uses are deemed improper. The company BORNACK will not be liable for any ensuing damages. The user bears the sole risk.

BRIEF DESCRIPTION

MATCHING CLIMBING SYSTEM COMPONENTS

RAILSTOP RS S

- Ladder types:
 - LMB Tr280, LMB Tr273.3
 - LMB Tr280 CC, LMB Tr273.3 CC
- Rail types:
 - LMB arrester rail, C-profile
 - LMB arrester rail, C-profile CC
- Rail attachments at a distance of 1.1 m or ladder attachments at a distance of 1.7 m
- Rail end locks, rigid or releasable, both at top and bottom, to prevent inadvertent exit from the rail
- Push-in lock to prevent twisted insertion of the fall arrester
- Rail joint connector
- Removal flap
- Fall arrester RAILSTOP RS So6
- Resting platform (hinged) on the ladder
- Roof exit with reinforcement spar

For more information, please refer to the product information for the listed accessories.

There are separate assembly instructions explaining how to assemble the various ladder types. See page 21 for information about the ladder type identification.

BRIEF DESCRIPTION

FALL ARRESTER PARTS

- Aluminium casing.
- Separate pawls to protect against falls and tilting:
 - Pawl A 'Climb' made of stainless steel with a polyamide tape energy absorber and an aluminium karabiner with a Twistlock-Plus fastener and swivel.
 - Pawl B 'Horizontal pull' made of stainless steel with textile connecting loop and karabiner with an aluminium Twistlock-Plus fastener.
- Maintenance-free bearings, rollers and joints.

ACCESSORIES

- Full body harness in compliance with EN 361 equipped with a sternal D-ring and a ventral multifunctional D-ring, e.g. ENERGY. Full body harnesses with just one of the two D-rings or full body harnesses with elastic straps are not compatible.

USE

- Arresting on the ladder

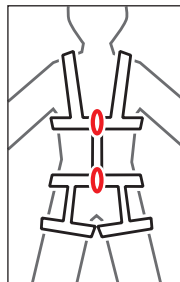

RAILSTOP RS S06

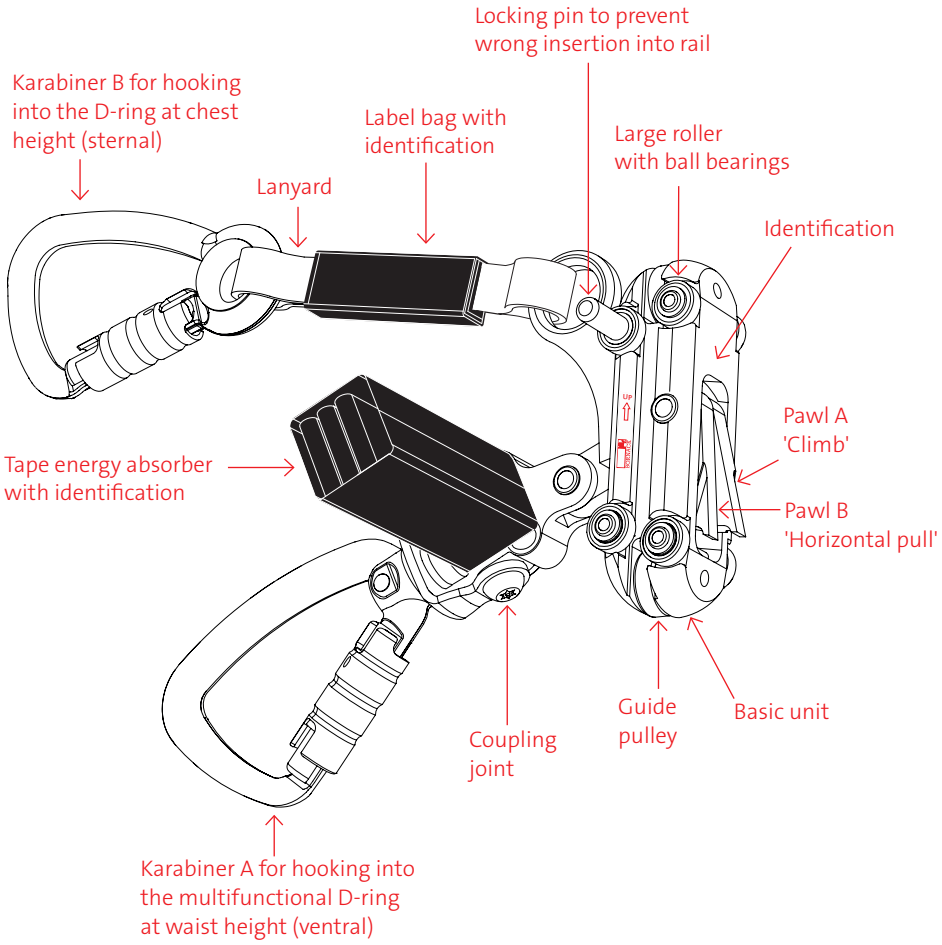

LADDER

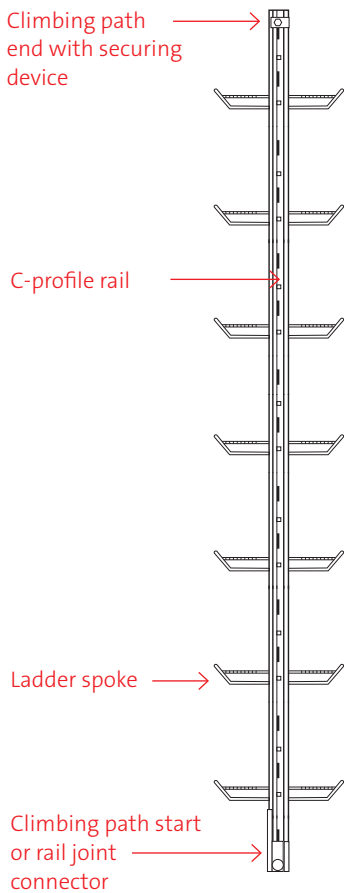

SECURING DEVICE FIXED

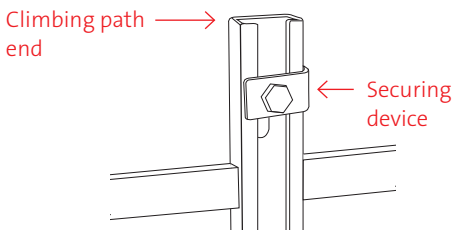

CURING DEVICE CAN BE OPENED

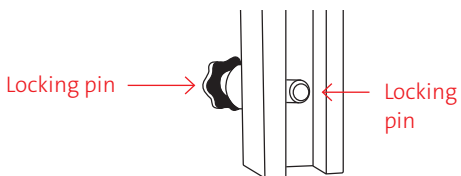

SECURING DEVICE

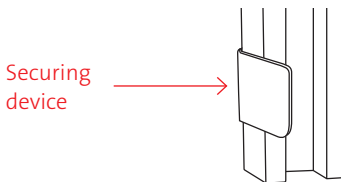

RESTING PLATFORM

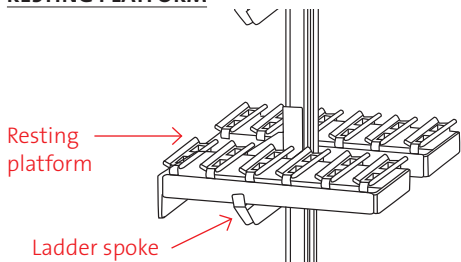

REMOVAL FLAP

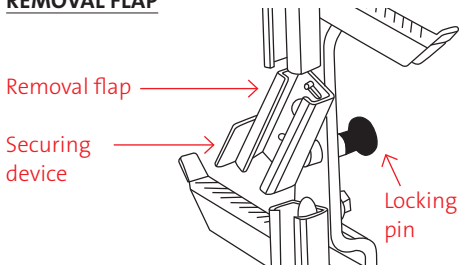

INFORMATION BEFORE USE



Always check before use!

- The user must have completely read and understood the User Manual before use.
- The personal protective equipment (PPE) may no longer be used in the case of even very minor faults. In case of damage or malfunctions, the device must be immediately withdrawn and not used, and then returned to the manufacturer and/or a workshop authorised by BORNACK for inspection. Faulty PPE may only be tested or repaired by BORNACK or in a workshop authorised by BORNACK.

VISUAL INSPECTION

- Check to ensure there is no obvious damage to karabiners, tape energy absorbers, joints, rivets, the basic unit, pawls, lanyard and that they are not bent.
- The coupling joint next to the tape energy absorber shows no signs of deformation.
- Check that the rail joints are tight and the distance between the rails is max. 3.0 mm.
- Identification is legible.
- Check to ensure that all rails, ladder attachments, exit and entry securing points, removal flaps, securing devices and fall arresters are complete and undamaged.
- Check that the end stops at the start and end of the ascent path are in place.
- The last inspection by an expert was carried out within the past 12 months.

FUNCTION TEST

- The fall arrester runs freely on karabiner A under horizontal strain and locks when pulled downwards.
- Check the spring function on the pawl and karabiner.
- Karabiner and its lock are fully functional.

RAILSTOP RS S06 IN USE

PREPARATION

A Insert a fall arrester at the end of the rail or at the removal point in the rail profile. Pull the locking pin of the climbing lock downwards and hold. Guide the fall arrester, with the pin pointing to the right, into the C-profile and past the locking pin. The securing device prevents incorrect engagement. The locking pin must automatically snap back into the locking position.

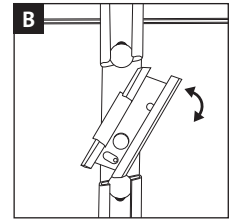
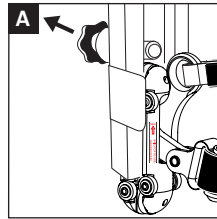

B Pull the locking pin backwards and turn the removal flap in a clockwise direction until it reaches the stopper. Insert the fall arrester with the locking pin pointing to the right. The integrated securing device prevents it from being inserted the wrong way round. Close the removal flap again! Swing back to the passing position and allow the locking pin to snap into the hook position.

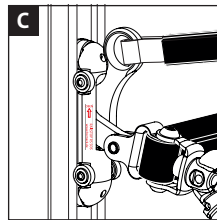

C Ensure that the arrow is pointing upwards. When the fall arrester is released, the device locks into the rail automatically. Manually check the function on the rail by lifting and lowering the fall arrester. The device must block when jerked down or released!

RAILSTOP RS S06 IN USE

Use the full body harness acc. to EN 361 with a sternal fall arrester D-ring and a ventral multifunctional D-ring, and observe the User Manual of the full body harness. Adjust the full body harness to the wearer's physical size. The harness may not be used if loose.



D Hook karabiner A of the fall arrester into the multifunction D-ring (waist height).

E Hook the fall arrester into the fall arrester D-ring at chest height (karabiner B).

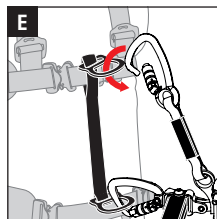
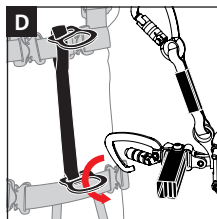

CAUTION THREAT TO LIFE:



The karabiners of the fall arrester must be hooked directly into the named D-rings of the full body harness and the connection may never be lengthened!

CAUTION THREAT TO LIFE:



Only use correctly mounted rail guides. During inspection, pay close attention to the rail joint connectors and the ladder attachments!

CAUTION:



If the full body harness becomes loose during ascent or descent, it must be correctly readjusted for a secure position.

RAILSTOP RS S06 IN USE

COMBINATION

F When combining this product with other parts, there is a risk of mutual impairment with respect to the function and safety. Compatibility must be assessed during the risk analysis. Only combine with personal protective equipment that bears a CE symbol. If you have any questions about compatibility or you require help with the risk analyses, feel free to contact BORNACK.

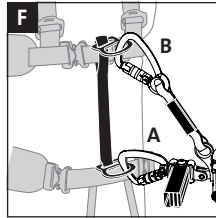

RAILSTOP RS S06 IN USE

USING THE FALL ARRESTER

CAUTION:

Before using, ensure adequate clearance below the user to prevent impact on a protruding object or the ground.

CAUTION:

When starting to ascend near the ground (approx. 1.5 m), it is possible, under unfavourable circumstances, that the legs will hit the ground when the fall is arrested.

During the ascent, pull karabiner A (ventral multifunction D-ring) horizontally and backwards (horizontal pull = back support), thereby unlocking it.

- Ascend or descend evenly and allow the fall arrester to slide with the user.
- Do not allow loads to be exerted onto the chest attachment! Keep the upper body upright. If the upper body tilts out of the normal position (due to a fall, unconsciousness etc.), the additional pawl B will block immediately!
- The user can achieve an ergonomic resting position quickly and safely by manually lifting and blocking the fall arrester and assuming a sitting/suspended position in the full body harness. Does not serve workplace positioning!



CAUTION:

The fall arrester must be blocked before the user is suspended or sits in the harness!

Application situation

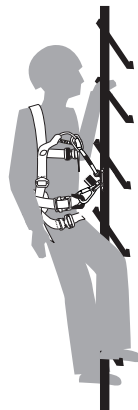

RAILSTOP RS S06 IN USE

CAUTION:



The user weight incl. tools and equipment may not exceed 140 kg!

CAUTION:



The user weight without tools and equipment may not undercut 50 kg!

CAUTION:



When using the fall arrester, ensure that the function of the pawl and the attached parts is not impeded. Otherwise, this can deactivate the locking function.

- The locked fall arrester can be easily released by slightly lifting the lower karabiner.
- When working on the climbing path, always secure with an additional holding rope in compliance with EN 358 (e.g. LORY HOLD) or with a fall arrester rope in compliance with EN 354/EN 355 (e.g. PYTHON). Lateral inclined loads may not be exerted onto the fall arrester.

CAUTION:



If several persons use the ladder at the same time, a minimum clearance of 3.0 m must be observed.

- Only release from the fall arrester, if there is no longer a risk of falling. If necessary, secure temporarily with a lanyard

RAILSTOP RS S06 IN USE

REMOVE FALL ARRESTER

G Move the fall arrester close to the locking pin. Secure somewhere else if the user is not in a safe work position. Pull the locking pin backwards. The locking pin in the C-profile is reset and releases the C-profile. Push the fall arrester toward the end of the C-profile and remove. Release the locking pin; it must automatically snap back into the locking position.

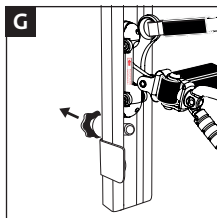

ROOF EXIT WITH REINFORCEMENT SPAR

H Move the fall arrester to just below the climbing lock. temporarily secure with a lanyard at a secure attachment point or directly into the fall guard of the roof system. Now open the climbing lock and remove the fall arrester from the rail of the ladder. Descend via the roof exit in reverse order.

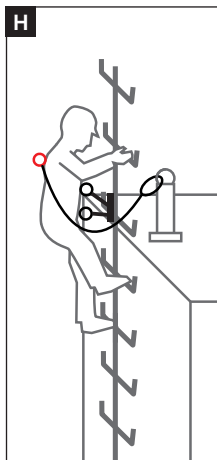

SAFETY INSTRUCTIONS

There is a risk to life if these safety instructions are not observed!

- The personal protective equipment (PPE) may no longer be used even in the case of very minor faults.
- Damaged, fall-stressed or dubious personal protective equipment or safety devices must be immediately withdrawn and not used. The inspection and decision about re-release and/or destruction is the responsibility of BORNACK or by the expert briefed by BORNACK about the inspection, including the corresponding certificate. This must be documented in the test card.
- Independent modifications or repairs are not allowed.
- The connection between the fall arrester and D-rings on the full body harness may not be lengthened or shortened.
- Rope protection is part of the personal fall prevention equipment and should be assigned to a specific person.
- The personal protective equipment may only be used by qualified staff that are familiar with the material. They must be proficient in handling the personal protective equipment and must have been briefed about the possible risks associated with its use.
- In accordance with the accident prevention guidelines (UVV), the users of fall protective equipment (Category III) must attend a theoretical training course and a practical training course. To this end, make use of the training competence of the BORNACK training centres: info@bornack.de
- Clothing and shoes must be suitable for the task at hand and the weather conditions.
- Only use if fully fit and healthy.
- Health impairments can jeopardise the safety of the user when working at heights or depths.
- This PPE may only be used as an arrester system in compliance with EN 361 with a sternal D-ring and central multifunctional D-ring.
- Before using, ensure adequate clearance below the user to prevent impact on a protruding object or the ground.
- Protect personal protective equipment during storing, use and transportation against the effects of heat (e.g. welding flames or sparks, burning cigarettes) and chemicals (e.g. acids, alkalis, oils) and mechanical impact (e.g. sharp edges).
- The combinability and protective effect of the PPE must be checked for each hazard situation (risk assessment).
- Due to the risk of non-visible tension corrosion, guided type fall arresters including a rigid anchorage line, made of rustproof steel, should not be installed in a highly corrosive atmosphere (e.g. over a swimming pool), unless special control measures were taken or compatibility has been verified.
- Before starting work, the responsible person must draw up a plan of rescue measures. that defines how to rescue casualties quickly and safely and ensures first aid measures. Casualties must be rescued within 20 minutes. BORNACK can help you draw up tailor-made rescue plans and includes these in the necessary training courses.
E-Mail-Hotline: info@bornack.de

SAFETY INSTRUCTIONS

- The local safety guidelines (e.g. in Germany, the DGUV Regulations 112-198 and 112-199 issued by the professional associations) and the accident prevention guidelines for the specific industry (UVV) must be observed.

OTHER

APPROVAL

Complies with the EC Directive 2016/425 for PPE.

Type testing and production monitoring by:

DEKRA Testing and Certification GmbH
Dinnendahlstr. 9, D-44809 Bochum
CE 0158

Quality management system certified to ISO 9001:2015.

Production monitoring by notified office in accordance with Category III.

REGULAR INSPECTIONS

- This PPE must be inspected by BORNACK or an by the expert briefed by BORNACK about the inspection at least once a year, including the corresponding certificate. The result must be documented in the test card at the end of this User Manual.

SALES

- The dealer must ensure that the User Manual is supplied in the language of the designated country. The respective translation must be authorised by BORNACK.

SERVICE

If you have any further questions about safe use of this PPE or other BORNACK services, such as:

- Risk analyses
- Rescue plans
- Training courses
- Expert inspections
- Technical inspections
- Maintenance + inspections

Please send your question to our E-Mail-Hotline: info@bornack.de

We will be happy to help!

MAINTENANCE

- If necessary, apply a small amount of oil on the joints so that the moving parts of the karabiner and other devices run smoothly. If possible, use precision mechanics oil. The bearings are continuously lubricated ball bearings.
- Maintenance may only be carried out by BORNACK or an by the expert briefed by BORNACK about the inspection, including the corresponding certificate. All instructions in this User Manual must be strictly observed.
- Protective equipment that is clean and well looked after will last longer!

OTHER

CLEANING

- Dry damp personal protective equipment in the air, not on artificial heat sources. Dry metal components with cloths.
- Clean soiled textile components (e.g. arrester harnesses and ropes) with lukewarm water and a little detergent for delicates. Then rinse carefully and allow to dry in the air. Other cleaning agents are not allowed!
- If disinfection is necessary, please contact the e-mail hotline: info@bornack.de
- If the personal protective equipment comes into contact with saltwater, keep it wet until it can be rinsed with plenty of distilled water.
- Wipe and clean soiled devices with a cloth, brush off or wash with lukewarm water and possibly a detergent for delicates, rinse with clean water. Other cleaning agents are not allowed.
- Use compressed air to blow on the unit if necessary.

LIFE SPAN

The following recommendation applies for the use of the RAILSTOP RS So6:

Maximum usage period after being used for the first time: 8 years

In ideal storage conditions and annual inspections, the product may be stored for up to 3 years before it is used for the first time without impacting on the stated maximum usage period. Every further year in storage reduces the final maximum allowed usage period by 1 year.

Metal parts are not subject to age-related life span deadlines. The expert makes a decision based on his technical expertise and the latest version of the standard.

The service life can only be prolonged by means of regular expert inspections and the replacement of age-related worn parts (e.g. aging of textile components).

For reasons of safety, intensive use and/or extreme application conditions such as sharp edges, chemical influences, UV radiation etc. will reduce the usage period. The company owner needs to take this into account in the workplace risk analysis.

The company owner must ensure compliance with the maximum usage period by documenting first-time use in the test card.

The test card at the end of this user manual must be presented during the regular expert inspections and be completed with the certificate by the manufacturer or an expert briefed about the inspection of the device.

Information about the typical application situations must be provided.

For more details, please visit is available online at www.bornack.de.

OTHER

REPAIRS

- For reasons of liability, repairs may only be carried out by BORNACK or in a workshop authorised in writing by BORNACK.
- Only original spare parts from the manufacturer may be used.

STORAGE

- Dry damp PPE **before** storage.
- Store in a dry place away from direct sunlight.
- Do not store PPE near radiators. Permanent exposure to temperatures below 0 °C or above +50 °C has a negative impact on the strength of the textile material and shortens the life span.
- Do not allow PPE to come into contact with aggressive substances (e.g. oils, grease, acids, chemicals). Precision mechanics oils may be applied to moving metallic parts during maintenance. Always ensure that textile PPE components do not come into contact with the oil.
- Do not store personal protective equipment close to aggressive substances (see above) because even the vapours of aggressive substances can have a negative effect on the strength of the PPE.
- Protected storage in the device case or device bag.

TRANSPORT

- Protected transport in the device case or device bag.

OTHER

PRODUCT IDENTIFICATION

The following identification is on the product:

Identification basic unit

Front side:

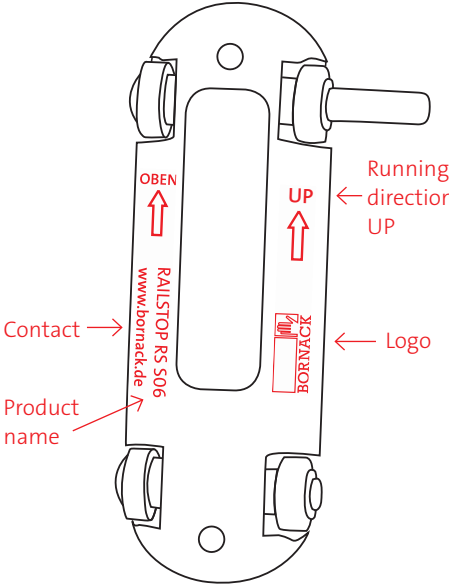

Rear side:

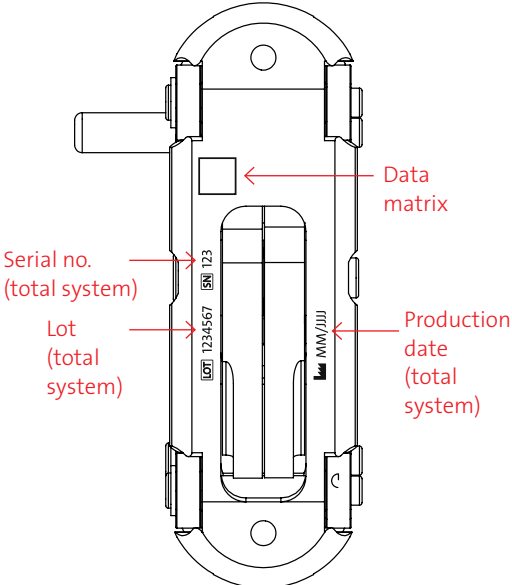

OTHER

Identification Label bag Lanyard:

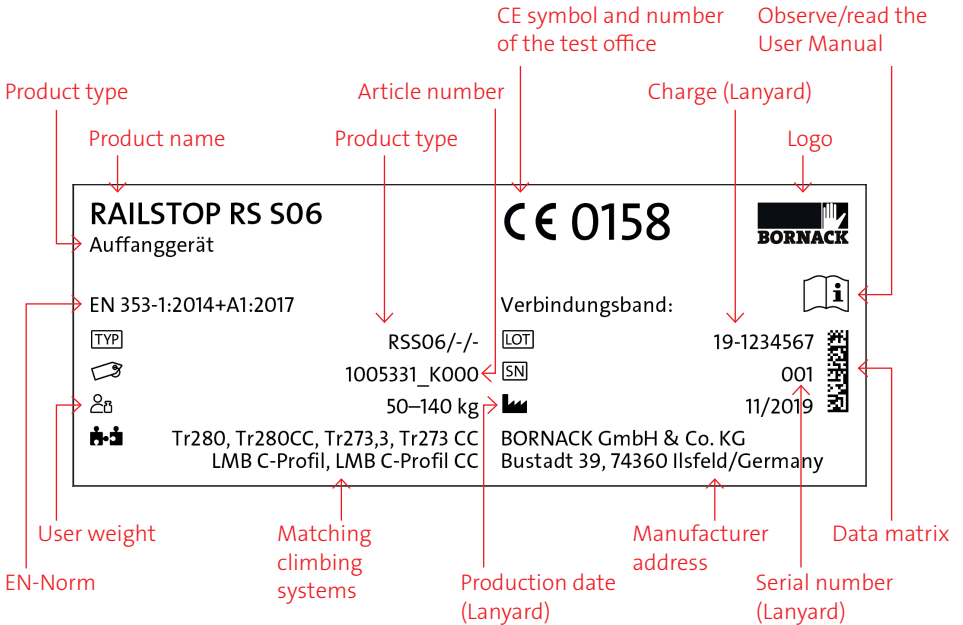

Identification tape energy absorber

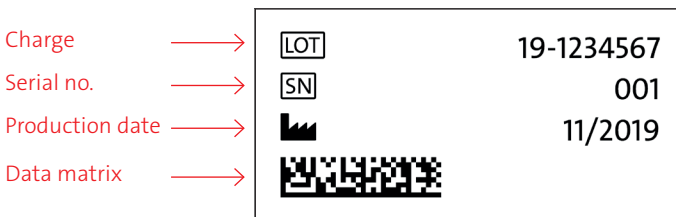

OTHER

Identification ladder:

Product name/type → **Steigleiter / Vertical ladder**
 LMB-T2260CC / LMB-T2273,3CC

Contact → **Loger Maschinenbau GmbH**
 www.loger-maschinenbau.de
 Nur Originalbauteile zulässig
 Only original components may be used

Product type → **Steigleiter / Vertical ladder**

Logo → **loger maschinenbau**

Language code pursuant to ISO 639-1 → **deEn**

Norm → **EN ISO 14122-5:2016**

Application temperature range → **+60°C**
cold climate

Repair → **✂**

Inspection → **☑**

Year of assembly → **2017**

Production → **TYP**

Only use ladders with a fall arrester and full body harness → **Sicherheit geprüft
 tested safe**

Observe/read the User Manual → **Sicherheit geprüft
 tested safe**

Type → **TYP**

Product name/type → **Steigleiter / Vertical ladder**

Application temperature range → **+60°C**

Repair → **✂**

Inspection → **☑**

Year of assembly → **2017**

Production → **TYP**

Year of assembly → **2017**

Application temperature range → **+60°C**
cold climate

Logo → **loger maschinenbau**

Product name/type → **Steigleiter / Vertical ladder**

Norm → **EN ISO 14122-5:2016**

Application temperature range → **+60°C**

Permissible Fall arresters

Mitlaufendes **Auffängergerät** einschl. fester Führung;
 Guided type **fall arrester** including rigid anchor line: **TYP**

RAILSTOP
 RS 306

BORNACK
 Bornack GmbH & Co. KG
 www.bornack.de

EN 353-1: 2014
 PA1: 2017 (2018)
 CE 0158

Steigleiter / Vertical ladder LMB:
 LMB-T2260 - LMB-T2260CC
 LMB-T273,3 - LMB-T273,3CC

Risk of falling! Ladders over 3 m in height may not be used without a fall arrester

Only use ladders with a fall arrester and full body harness

Observe/read the User Manual

Steigleiter nur mit **CE-Auffängergerät** und Auffanggurt benutzen!
 (Gebrauchsanleitung und einschlägige UVV beachten!)
 (Regelungen nur durch eingewiesenes Personal!)

CE: EN 353-1 für mit LMB-Steigleiter, siehe **TYP**
 Only trained personnel should enter!

Observe/adhere to the provisions of the user manual and the applicable Accident Prevention Regulations. Use the vertical ladder only with CE-fall arrester and safety harness!

Norm

Risk of falling! Ladders over 3 m in height may not be used without a fall arrester

Only use ladders with a fall arrester and full body harness

Observe/read the User Manual

Verkehrslast Steigleiter:
 Max. **150 kg**/Benutzer
 Abstand: **3 m**

Traffic load vertical ladder:
 Max. **150 kg**/user
 Distance: **3 m**

loger maschinenbau

150
 kg/99

Useful load per person
 Minimum clearance

Logo

TEST CARD

FOR ANNUAL MONITORING

The test list and the corresponding certificate must be completed in full during the annual inspection by the expert briefed by the manufacturer about the inspection.

This test list does not claim to cover all test criteria and does not relieve the expert from his decision about the overall condition.

Type RAILSTOP RS So6: _____

Production date: _____ / _____ / _____
Basic unit Lanyard Tape energy absorber

Charge: _____ / _____ / _____
Basic unit Lanyard Tape energy absorber

Serial no.: _____ / _____ / _____
Basic unit Lanyard Tape energy absorber

Purchase date: _____

Date of first use: _____

Life span ends at the latest: _____

	Date	Signature	Next Inspection	Reason for inspection
1. year				
2. year				
3. year				
4. year				
5. year				
6. year				
7. year				
8. year				

TEST CARD

FOR ANNUAL MONITORING

Please complete:

	1. year	2. year	3. year	4. year	5. year	6. year	7. year	8. year
Straps undamaged?								
No chemical soiling?								
Seams undamaged?								
No deformation of metal parts?								
Karabiners are in place & fully functional?								
Condition of the springs/ rivets/axes OK?								
No corrosion damage?								
Smooth snapper function?								
Function test: runs/clamps?								
No mechanical damage?								
Label legible?								
User Manual available?								
Guide rollers functional/ undamaged?								
OK								
Blocked								



TEST CARD

FOR ANNUAL MONITORING

The test list and the corresponding certificate must be completed in full during the annual inspection by the expert briefed by the manufacturer about the inspection.

This test list does not claim to cover all test criteria and does not relieve the expert from his decision about the overall condition.

Rail/ladder type: _____

Production date: _____ / _____ / _____

Charge: _____ / _____ / _____

Serial no.: _____ / _____ / _____

Purchase date: _____

Date of first use: _____

Life span ends at the latest: _____

	Date	Signature	Next Inspection	Reason for inspection
1. year				
2. year				
3. year				
4. year				
5. year				
6. year				
7. year				
8. year				

EU DECLARATION OF CONFORMITY



EU Declaration of Conformity

The manufacturer or his authorised representative established within the EU

BORNACK GmbH & Co. KG
Bustadt 39
74360 Ilsfeld
Germany

hereby declares that the following personal protective equipment

Guided type fall arrester including an anchor line
RAILSTOP RS S06 (guided type fall arrester)
RAILSTOP RS S (rigid anchor line)

- is in conformity with the relevant harmonisation legislation according to Annex V (Module B) of the Regulation (EU) 2016/425 on personal protective equipment according to Article 19 (category III PPE) and is examined to **EN 353-1:2014+A1:2017**
- is identical to the PPE that is the object of the **EU type-examination certificate No. ZP/B112/19**

issued by

DEKRA Testing and Certification GmbH
Dinnendahlstraße 9
44809 Bochum
Germany
CE 0158

- is subject to the assessment of conformity to type, based on internal production control plus supervised product checks according to Module C2 of the Regulation (EU) 2016/425 for personal protective equipment (category III PPE), monitored by the notified body

DEKRA Testing and Certification GmbH
Dinnendahlstraße 9
44809 Bochum
Germany
CE 0158

2 December 2019

BORNACK GmbH & Co. KG

Klaus Bornack
Managing Director





FALLSTOP

Safety equipment for securing and rescuing at heights and depths

SAFEPOINT

Planning and assembly of permanently installed safety systems

BORNACK GmbH & Co. KG

Bustadt 39
74360 Ilsfeld
Germany

Tel + 49 (0) 70 62 / 26 90 0-0
Fax + 49 (0) 70 62 / 26 90 0-550
info@bornack.de
www.bornack.de

© BORNACK – Subject to technical changes
Reprinting, even of excerpts, is only permitted with written consent
Status: 07/2020 GAL Art.-Nr. 8000164_EN anh

