

FS51

User Manual

FS51

Safety hook

Subject to technical changes

BRIEF DESCRIPTION

INTENDED USE

The safety hook FS51 is part of personal protective equipment (PPE) of category III to prevent falls from heights. The FS51 serves to connect several parts of a securing system or for anchoring to an anchor point. The tensile strength of the FS51 is 20 kN along the main axle.

Maximum number of users: 1 person

All other uses are deemed improper. The company BORNACK will not be liable for any ensuing damages. The user bears the sole risk.

FUNCTION

The safety hook FS51 has an automatic lock. This prevents unintentional removal of the safety hook from the anchor point or an eyelet.

Also for type FS51/SG: When the screw is closed, the screw lock acts as a third lock and prevents the safety hook opening.

EQUIPMENT

- The safety hook is made of steel and has an automatic lock
- Also for type FS51/SG: Screw lock as a third lock
- Fastener opening width: 18 mm
- Diameter of the eyelet/attachment ring: 22 mm
- Length of the safety hook (inside): 100 mm

USE

- Attachment
- Connection of several parts of a securing system.

FS51

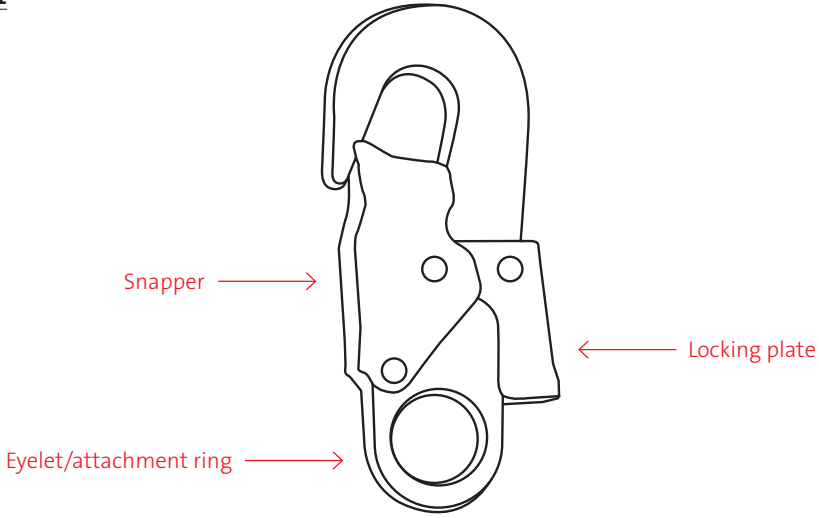

FS51/SG

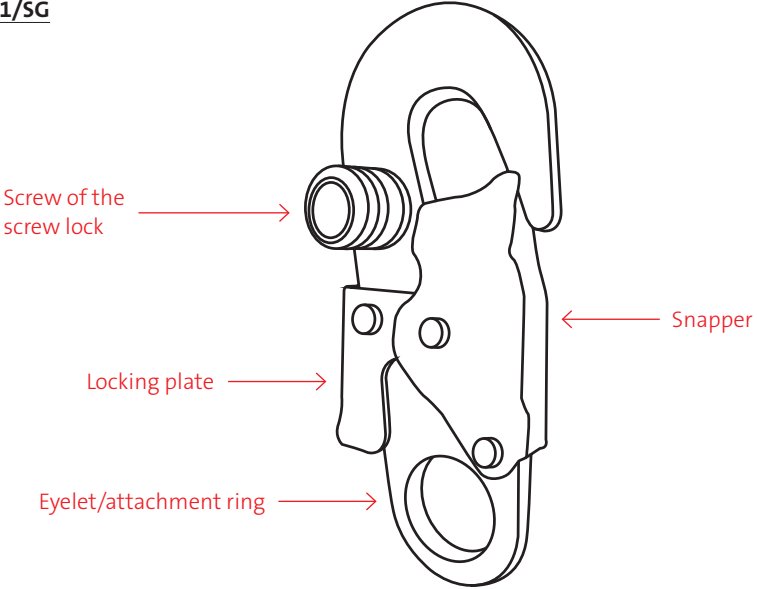

INFORMATION BEFORE USE



**Always check every time
before use!**

- The personal protective equipment (PPE) may no longer be used in the case of even very minor faults.
- Faulty PPE components may only be tested or repaired by BORNACK or in a workshop authorised in writing by BORNACK.
- Regular inspections are essential because the safety of the user depends on the efficiency and durability of the PPE.
- The user must have completely read and understood the User Manual before use.

VISUAL INSPECTION

- No deformations, cracks, grooves, notches, wear or other damage.
- No soiling of the safety hook.
- The last inspection by an expert was carried out within the past 12 months.

FUNCTION TEST

- Closing plate and snapper move smoothly and both snap automatically back into the fastening position.
- As long as the closing plate is closed, the snapper cannot be opened.
- Additional function test for type FS51/SG: the screw of the screw lock can be opened and closed. When the screw lock is closed, the snapper cannot be opened despite the actuated closing plate.

FS51 IN USE

OPENING AND CLOSING THE SAFETY HOOK

- A** Only for type FS51/SG: Open the screw lock anticlockwise.
- B** Press the locking plate and snapper one after another.
- C** Attach the safety hook to an anchor point, eyelet etc.
- D** After the locking plate and snapper are released, they close automatically, unless an object (harness strap or similar) block the closing process.

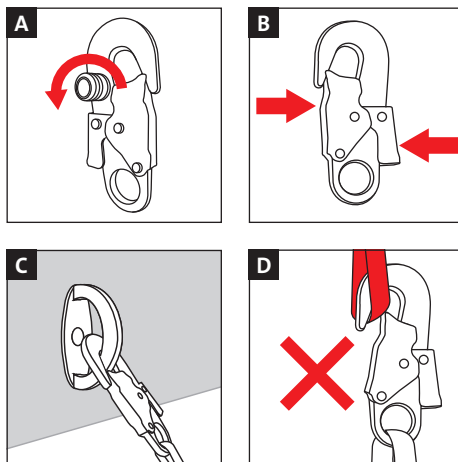

CAUTION: RISK TO LIFE!



Check that the locking plate and snapper are closed!

CAUTION: RISK TO LIFE!



If the locking plate and snapper cannot be closed on an anchor point or an eyelet etc., this safety hook may not be used for this anchor point or eyelet etc.!

CAUTION: RISK TO LIFE!



Application situations in which pressure would be exerted onto the locking plate and snapper (e.g. weight on the safety hook, clamping of the safety hook, application situations in tight spaces) are not allowed for the FS51 without a screw lock. For these kinds of application situations, connectors with a 3rd lock (e.g. TL+ karabiner, FS51/SG) should be used to prevent unintentional opening of the lock!

FS51 IN USE

E Only for type FS51/SG: Close the screw lock clockwise.

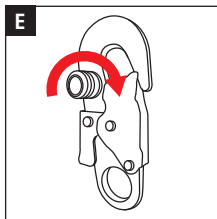

ATTENTION:



Check that the screw lock is closed tightly enough and that the snapper can no longer be opened even if the locking plate is pressed.

LOAD DIRECTIONS

F Only use the safety hook in a manner that ensures that it can be aligned optimally in the direction of the load.

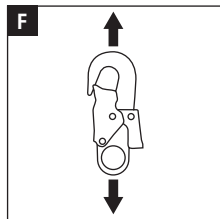
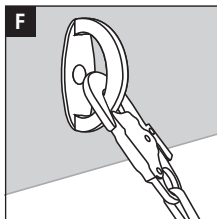

G Do not exert shearing loads onto the safety hook.

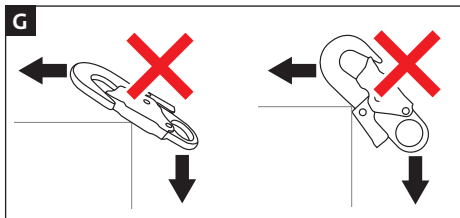

H Do not exert loads onto the safety hook via the locking plate/snapper.

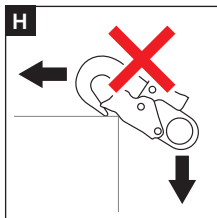

I Do not use the safety hook to connect more than two components with one another.

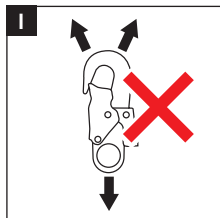

CAUTION: RISK TO LIFE!



Connecting the safety hook with wide straps can reduce the strength of the pipe/scaffold hook and/or the straps.

FS51 IN USE

ANCHOR POINTS

CAUTION: RISK TO LIFE!



Anchor points must be adequately strong (observe 12 kN according to EN 795 and/or DGUV Regulation 112-198)!

ATTENTION:



Only use anchor points at which the safety hook can be aligned optimally in the direction of the load (see section LOAD DIRECTIONS).

CAUTION: RISK TO LIFE!



When selecting the attachment point, minimise the fall height and/or the free fall!

USE IN ARRESTING SYSTEMS

J If the safety hook is used in an arrester system, only full body harnesses that comply with EN 361 may be used.

Observe the User Manual of the full body harness.



ATTENTION:



The length of the safety hook needs to be taken into account when used in an arresting system because this impacts on the fall path.

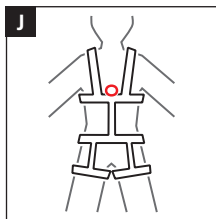

SAFETY REGULATIONS

There is a risk to life if these safety instructions are not observed!

- The personal protective equipment (PPE) may no longer be used even in the case of very minor faults.
- Damaged, fall-stressed, dubious personal protective equipment or safety devices must be immediately withdrawn and not used. The equipment may only be inspected by an expert in compliance with DGUV principle 312-906, BORNACK and/or a workshop authorised in writing by BORNACK. This must be documented in the test card.
- Independent modifications or repairs are not allowed.
- Rope protection is part of the personal fall prevention equipment and should be assigned to a specific person.
- The personal protective equipment may only be used by qualified staff that are familiar with the material. They must be proficient in handling the personal protective equipment and must have been briefed about the possible risks associated with its use.
- In accordance with the accident prevention guidelines (UVV), the users of personal protective equipment against falls (Category III) must attend a theoretical training course and a practical training course. Make use of the training competence of the BORNACK training centres: info@bornack.de
- Accessories from other manufacturers may only be used if approved by BORNACK and may not impair the function and safety of the protective equipment.
- Clothing and shoes must be suitable for the task at hand and the weather conditions.
- Only use if fully fit and healthy. Health impairments can jeopardise the safety of the user when working at heights or depths.
- If this PPE is used as an arrester system (free fall is possible), only full body harnesses that comply with EN 361 may be used.
- Calculation of the possible fall path if all necessary PPE components are used correctly: (if necessary braking path HSG) + surplus lanyard (situation-dependent) + braking path energy absorber (max. 1.75 m) + height of D-ring (1.5 m) + safety reserve 1.0 m.
- Before using, ensure adequate clearance below the user to prevent impact on a protruding object or the ground.
- Protect PPE during storing, use and transportation against the effects of heat (e.g. welding flames or sparks, burning cigarettes) and chemicals (e.g. acids, alkalis, oils) and mechanical impact (e.g. sharp edges).
- The combinability and protective effect of the PPE must be checked for each hazard situation (risk assessment).
- If a casualty hangs motionless in a full body harness for a longer time, blood cannot flow back from the legs and/or the flow may be interrupted. This can lead to a suspension trauma, a circulatory shock with serious to fatal consequences.

SAFETY REGULATIONS

- Before starting work, the responsible person must draw up a plan of rescue measures that define how to rescue casualties quickly and safely and ensures first aid measures. Casualties must be rescued within 20 minutes. BORNACK can help you draw up tailor-made rescue plans and includes these in the necessary training courses.
E-mail hotline: info@bornack.de
- The local safety guidelines (e.g. in Germany, the DGUV Regulations 112-198 and 112-199 issued by the professional associations) and the accident prevention guidelines for the specific industry (UVV) must be observed.
- Lanyards with manual locking fasteners (e.g. type FS51/SG) should only be used if the user does not hook it in and out very frequently, e.g. several times during a work day.

OTHER

APPROVAL:

Complies with the EC Directive 2016/425 for PPE.

Type testing and production monitoring by:

DEKRA Testing and Certification GmbH
Dinnendahlstr. 9, D-44809 Bochum
CE 0158

Quality management system certified to
DIN EN ISO 9001:2015.

Production monitoring by notified office in
accordance with Category III.

REGULAR INSPECTIONS

- This personal protective equipment must be inspected at least once a year by an expert in compliance with DGUV Principle 312-906. The result must be documented in the test card at the end of this User Manual.

SALES

- The dealer must ensure that the User Manual is supplied in the language of the designated country. The respective translation must be authorised by BORNACK.

SERVICE

If you have any further questions about this PPE or other BORNACK services, such as:

- Risk analyses
- Rescue concepts
- Training courses
- Expert inspections
- Technical inspections
- Maintenance + inspections

please contact our e-mail hotline:
info@bornack.de

We will be happy to help!

MAINTENANCE

- If necessary, apply a small amount of oil on the joints so that the moving parts of the karabiner and other devices run smoothly. If possible, use precision mechanics oil. Ensure that the oil does not come into contact with textile PPE components.
- Maintenance may only be carried out by a qualified expert in compliance with DGUV Principle 312-906. All instructions in this User Manual must be strictly observed.
- Protective equipment that is clean and well looked after will last longer!

OTHER

CLEANING

- Dry damp personal protective equipment in the air, not on artificial heat sources. Dry metal components with cloths.
- If disinfection is necessary, please contact the e-mail hotline:
info@bornack.de
- If the personal protective equipment comes into contact with salt-water, keep it wet until it can be rinsed with plenty of distilled water.
- Use compressed air to blow on the unit if necessary.

LIFE SPAN

Metal parts are not subject to age-related life span deadlines. The expert makes a decision about these parts based on his technical expertise.

For reasons of safety, intensive use and/or extreme application conditions such as sharp edges, chemical influences etc. will reduce the usage period. The company owner needs to take this into account in the workplace risk analysis.

The test card at the end of this user manual must be presented during the regular expert inspections and be completed by an expert.

For more details, please visit www.bornack.de.

REPAIRS

- For reasons of liability, repairs may only be carried out by BORNACK or in a workshop authorised in writing by BORNACK.
- Only original spare parts from the manufacturer may be used.

STORAGE

- Dry wet PPE **before** storage.
- Store in a dry place away from direct sunlight.
- Do not store PPE near radiators. Permanent exposure to temperatures above +50 °C has a negative impact on the strength of the textile material and shortens the life span.
- Do not allow PPE to come into contact with aggressive substances (e.g. oils, grease, acids, chemicals). Precision mechanics oils may be applied to moving metallic parts during maintenance. Always ensure that textile PPE components do not come into contact with the oil.
- Do not store personal protective equipment close to aggressive substances (see above) because even the vapours of aggressive substances can have a negative effect on the strength of the PPE.
- Protected storage in the device case or device bag.

TRANSPORT

- Protected transport in the device case or device bag.

OTHER

PRODUCT IDENTIFICATION

The following identification is on the product:

Identification front side FS51:

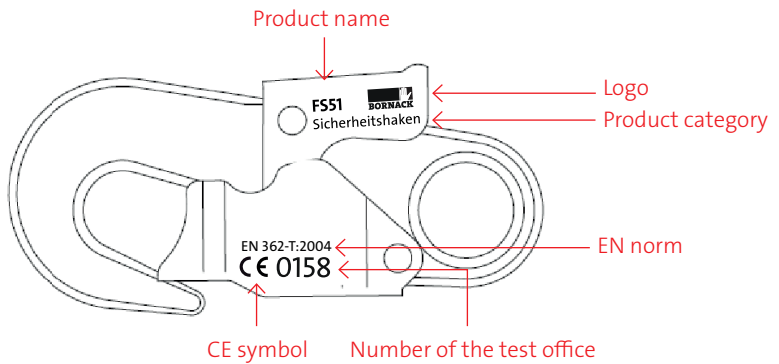

Identification rear side FS51:

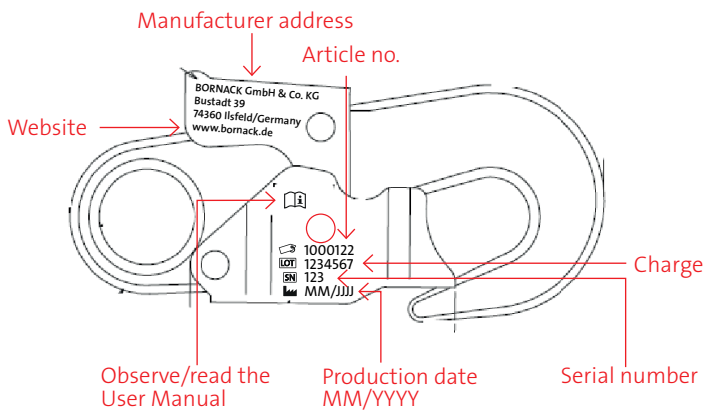

OTHER

Identification front side FS51/SG:

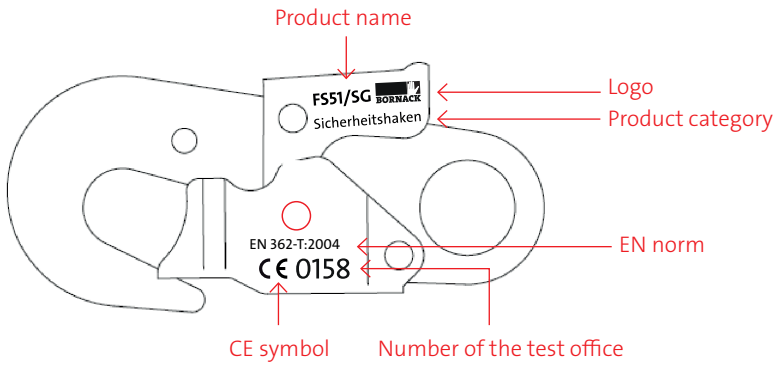

Identification rear side FS51/SG:

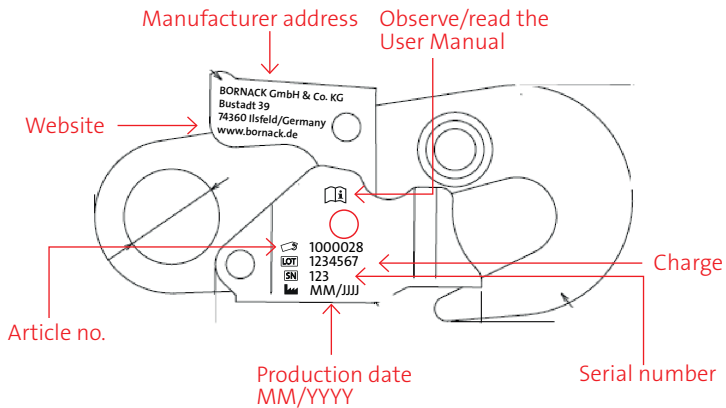



TEST CARD

FOR ANNUAL MONITORING

The test list must be completed in full by the expert during the annual inspection.

This test list does not claim to cover all test criteria and does not relieve the expert from his decision about the overall condition.

Type product name: _____

Production date: _____

Charge no.: _____ Serial no.: _____

Purchase date: _____

Date of first Use: _____

Maximum life span until: /

	Date	Signature	Next inspection	Reason for inspection
Year 1				
Year 2				
Year 3				
Year 4				
Year 5				
Year 6				
Year 7				
Year 8				
Year 9				
Year 10				

TEST CARD

FOR ANNUAL MONITORING

Please complete:

	Year 1	Year 2	Year 3	Year 4	Year 5	Year 6	Year 7	Year 8	Year 9	Year 10
No mechanical damage?										
No deformation?										
No chemical soiling?										
No corrosion damage?										
Condition of the springs/ rivets/axes OK?										
Smooth snapper function?										
when the closing plate is closed, is it impossible to open the snapper?										
Additional check for type FS51/SG.:										
Is the screw of the screw lock in place?										
when the screw lock is closed, is it impossible to open the actuated closing plate?										

Continued on the next page

EU DECLARATION OF CONFORMITY



EU Declaration of Conformity

The manufacturer or his authorised representative established within the EU

BORNACK GmbH & Co. KG
Bustadt 39
74360 Ilsfeld
Germany

hereby declares that the following personal protective equipment

Connector
FS51 Sicherheitshaken

- is in conformity with the relevant harmonisation legislation according to Annex V (Module B) of the Regulation (EU) 2016/425 on personal protective equipment according to Article 19 (category III PPE) and is examined to **EN 362:2004**
- is identical to the PPE that is the object of the **EU type-examination certificate No. ZP/B070/19**

issued by

DEKRA Testing and Certification GmbH
Dinnendahlstraße 9
44809 Bochum
Germany
CE 0158

- is subject to the assessment of conformity to type, based on internal production control plus supervised product checks according to Module C2 of the Regulation (EU) 2016/425 for personal protective equipment (category III PPE), monitored by the notified body

DEKRA Testing and Certification GmbH
Dinnendahlstraße 9
44809 Bochum
Germany
CE 0158

27 June 2019

BORNACK GmbH & Co. KG

Klaus Bornack
Managing Director

A handwritten signature in blue ink, appearing to be 'K Bornack', written over the printed name and title.



FALLSTOP

Safety equipment for securing and rescuing at heights and depths

SAFEPOINT

Permanently installed safety systems for architects and industry

BORNACK GmbH & Co. KG

Bustadt 39
74360 Ilsfeld
Germany

Tel + 49 (0) 70 62 / 26 90 0-0
Fax + 49 (0) 70 62 / 26 90 0-550
info@bornack.de
www.bornack.de

