

ROPSTOP03

User Manual

ROPSTOP03

Guided type fall arrester including a flexible anchor line

Subject to technical changes

BRIEF DESCRIPTION

INTENDED USE

The ROPSTOP03 fall arrester is part of personal protective equipment (PPE) of category III to prevent falls from heights. In combination with a full body harness acc. to EN 361 and a tape energy absorber, the ROPSTOP03 fall arrester only serves to secure one person. ROPSTOP03 with a tape energy absorber on the fall arrester is used as a securing system on roofs or e.g. platforms. The fall arrester ROPSTOP03 is also approved for horizontal use. See information on page 12 and 13.

The ROPSTOP03 model with a tape energy absorber on the safety rope serves to secure one person on ladders etc. and is not suitable for horizontal use.

This equipment may only be used by persons familiar with personal preventive equipment and the risks associated with working in areas where there is a risk of falling.

Maximum number of users: 1 person

Application temperature: -30 °C to +50 °C

Maximum user weight including clothing and equipment: 100 kg

All other uses are deemed improper. The company BORNACK will not be liable for any ensuing damages. The user bears the sole risk.

FUNCTION

The fall arrester is unlocked by lifting the attachment strap and slides along the rope. If an attachment strap is pulled downwards, this clamps the fall arrester tightly onto the rope. The fall is arrested.

EQUIPMENT

- Full body harness in compliance with EN 353-2, length of attachment strap 0.1 m
 - Tape energy absorber acc. to EN 355 with connector acc. to EN 362, length incl. attachment strap of the fall arrester 0.6 m
- flexible guide made of polyamide acc. to EN 353-2 and CNB/P/11.075:
 - GEO16.0 safety rope 16mm and TECSP11.0 safety rope 11mm
 - Connector acc. to EN 362, self-securing and self-locking
 - Tape energy absorber acc. to EN 355 between the connector acc. to EN 362 and the rope

BRIEF DESCRIPTION

ACCESSORIES

- For ROPSTOPO₃ fall arresters in the model without an energy absorber on the fall arrester:
 - Karabiner/connector acc. to EN 362 for connection with the full body harness, e.g. karabiner 362 D SUPERSTRONG with the TWISTLOCK PLUS fastener

USE

- Securing
- Retention
- Arresting

Device type	ROPO ₃ K	ROPO ₃
Guide type	ROPSo ₁ K /	ROPSo ₁ /
Norms	EN 353-2; CNB/P/11.075	EN 353-2
Use over edge	Yes	No
Position of the energy absorber	on the device	on the guide

Only use over edges with device type ROPo₃K and guide type ROPSo₁K

ROPSTOP03 TYPE ROP03K/

ROPSTOP03 TYPE ROP03/

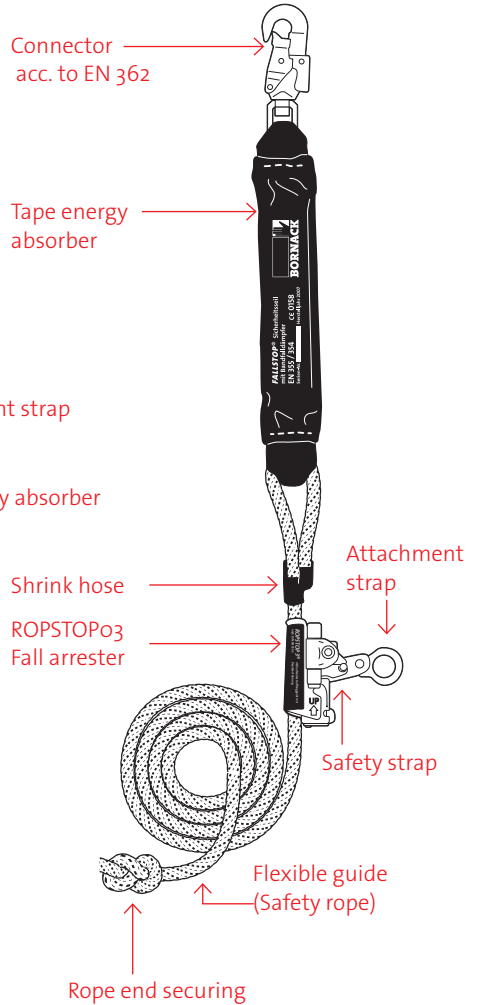
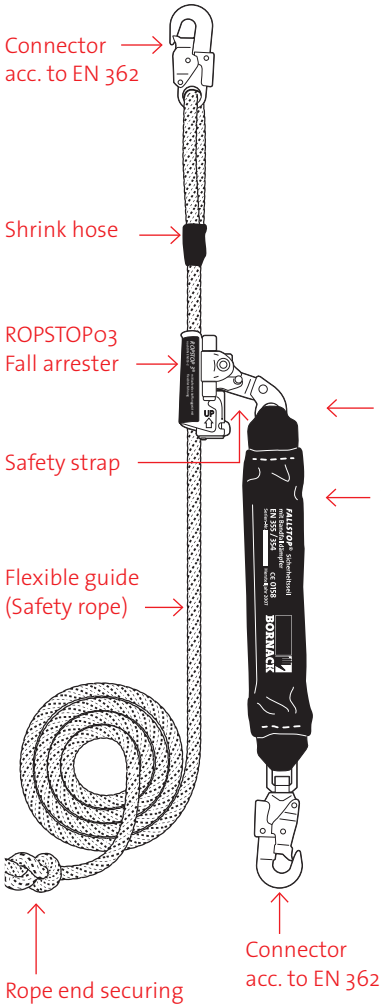
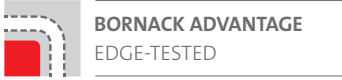

FALL ARRESTER ROPSTOP03

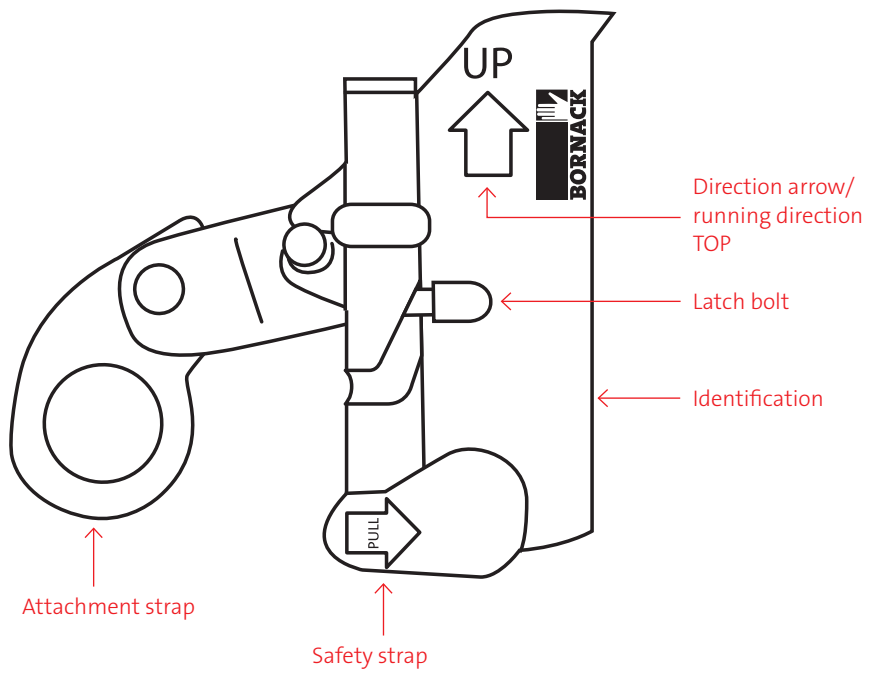

INFORMATION BEFORE USE



**Always check every time
before use!**

- The personal protective equipment (PPE) may no longer be used in the case of even very minor faults.
- Faulty PPE components may only be tested or repaired in a workshop authorised by BORNACK.
- Regular inspections are essential because the safety of the user depends on the efficiency and durability of the PPE.
- The user must have completely read and understood the User Manual before use.

VISUAL INSPECTION

- Check that the fall arrester, tape energy absorber, connector acc. to EN 362 and safety rope are complete and fully functional.
- Lay out the rope completely and check the condition. The rope may not show any visible signs of wear along the entire length.
- Can you see or feel any damage in the textile components?
- The last inspection by an expert was carried out within the past 12 months.

FUNCTION TEST

- Attach the safety rope with the connector acc. to EN 362 to a safe anchor point. Pull the attachment strap forcefully downwards. The fall arrester must be clamped tightly to the safety rope.

ROPSTOPO3 IN USE

ATTENTION:



The ROPSTOPO3 fall arrester is part of the personal fall prevention equipment and should be assigned to a specific person. Avoid alternating use.

PREPARATION: INSERT ROPE

- A** Hold the device on your open palm. Direction arrow points UPWARDS.
- B** Lift the securing strap and push the securing lock downwards. Lift the securing strap and open the device.
- C** Lift the securing strap and open the fall arrester. Place the guide rope into the device and close the device. Check that the force application direction is correct: arrow points UPWARDS!
- D** Push the latch bolt from the 'park position': the bayonet fastener snaps closed automatically.

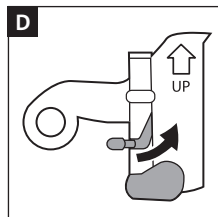
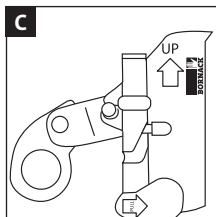
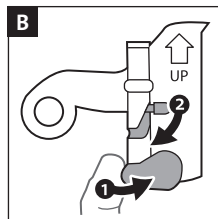
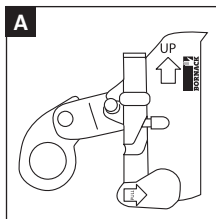

ATTENTION:



Do not reach between the rope and the device when inserting the rope/closing the device. Risk of injury!

Observe the User Manual of the RFZ climbing system when used in combination with this RFZ climbing system.



ROPSTOP03 IN USE

CHECK:

Is ROPSTOP03 attached correctly? The device must hold its position on the rope and may not slide down. The device must block when jerked down! The device can be moved freely upwards.

The system is now operational and work can begin.

CAUTION: RISK TO LIFE!



When inserting the rope, observe the 'UP' marking!

CAUTION: RISK TO LIFE!



ROPSTOP03 fall arrester without tape energy absorbers may only be used on safety ropes with tape energy absorbers! There is a potentially fatal risk, if there is no tape energy absorber in the system! In the case of ROPSTOP03 fall arrester with tape energy absorbers, ensure that no other tape energy absorbers are used in the system.

ATTENTION:



Only use connectors and safety ropes approved by the manufacturer for the ROPSTOP03.

ROPSTOP03 IN USE

SAFETY ROPE

E Lay out the rope carefully. The rope may not be knotted.

CAUTION: RISK TO LIFE!



The conditions of wet or frozen areas may vary! There is little to no braking effect on wet or frozen ropes!

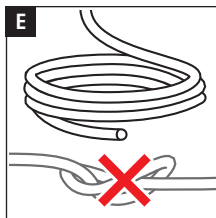

ATTACHMENT TO THE ANCHOR POINT

F Attach the connector acc. to EN 362 of the safety rope to a secure anchor point (EN 795).

CAUTION: RISK TO LIFE!



The anchor point must be able to withstand a tensile load of 7,5 kN (observe EN 795).

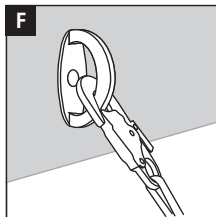

CAUTION: RISK TO LIFE!



When selecting the attachment point, minimise the fall height and/or the free fall!

G Protect the connector acc. to EN 362 against shearing forces (bending).

ATTENTION:



The safety rope of the ROPSTOP03 may not be used in a noose or cow hitch! Instead, create an attachment point with an anchor sling!

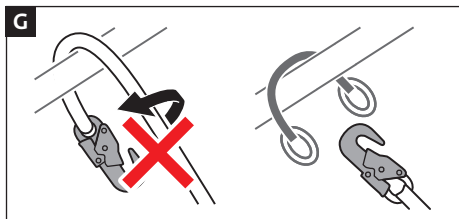

Read the User Manual of the connector according to EN 362.



ROPSTOP03 IN USE

ATTACHMENT TO THE FULL BODY HARNESS

Observe the User Manual of the full body harness acc. to EN 361.



Read the User Manual of the connector according to EN 362.



It is recommended using the front D-ring, if the work position allows this.

ROPSTOP03 fall arrester with tape energy absorber:

H Hook the connector acc. to EN 362 of the tape energy absorber of the fall arrester into the front D-ring of the full body harness marked with an 'A'.

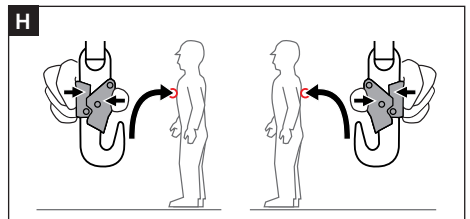

ROPSTOP03 fall arrester without tape energy absorber:

I Using a connector acc. to EN 362 connect the attachment strap of the fall arrester energy absorber to the front D-ring of the full body harness marked with an 'A'.

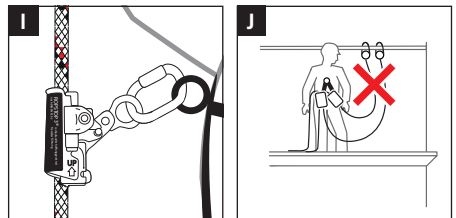

ATTENTION:



In the case of ROPSTOP03 fall arresters without tape energy absorbers, the attachment strap must be connected directly to the D-ring using a connector acc. to EN 362. Extensions are not allowed!

CAUTION: RISK TO LIFE!



The length of the lanyard needs to be taken into account when used in an arresting system because this impacts on the fall path.

J Two individual securing systems ROPSTOP03 may not be used in parallel!

ROPSTOP03 IN USE

SECURING ONE PERSON ON PLATFORMS/ RESTRAINT & POSITIONING

CAUTION: RISK TO LIFE!



If there is a risk of falling over an edge when used, only the ROPSTOP03 with a tape energy absorber on the fall arrester may be used because the edge can hinder the absorbing properties of the tape energy absorber.

K If possible, select an attachment point vertically above the work point.

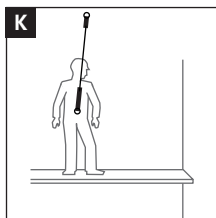

L The anchor point must lie above where the person is standing.

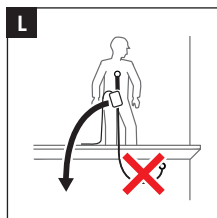

M Do not select an anchor point to the side of the secured person! Otherwise, the person can bang into parts or a wall.

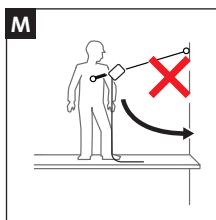

N When working on the fall edge, position the arresting device on the safety rope so that the user can just reach the fall edge but cannot fall.

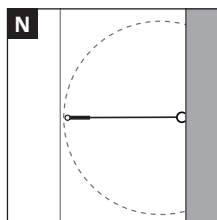

O Avoid slack rope. Slack rope extends the fall path.

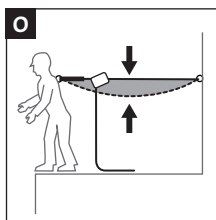

ATTENTION:



Always keep the safety rope taut. A fall over the edge should be ruled out if possible.

CAUTION: RISK TO LIFE!



Only the safety rope models TECSP11.0 and GEO16.0 are suitable for use over edges.

ROPSTOP03 IN USE

P Ensure adequate space below the edge.

CAUTION: RISK TO LIFE!



The excess rope/slack rope is the difference between the securing length a and the distance between the anchor point and fall edge b and needs to be calculated into the required space!

CAUTION: RISK TO LIFE!



The conditions of wet or frozen areas may vary!
There is little to no braking effect on wet or frozen ropes!

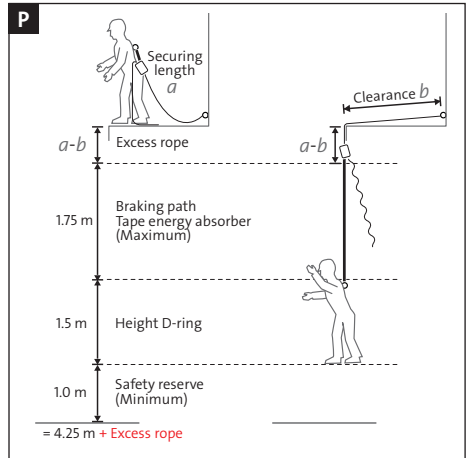

ROPSTOPO3 IN USE

SECURING ONE PERSON WHEN CLIMBING / WITH GUIDED TYPE FALL ARRESTER

ATTENTION:



In this application, the ROPSTOPO3 with a tape energy absorber must be used on the safety rope.

Q Attach the ROPSTOPO3 safety rope to the attachment point above the ascent. Place the ROPSTOPO3 fall arrester onto the safety rope.

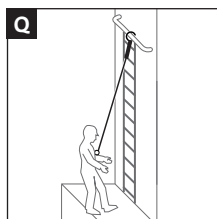

R Using a suitable connector acc. to EN 362 connect the attachment strap of the ROPSTOPO3 to the front D-ring of the full body harness.

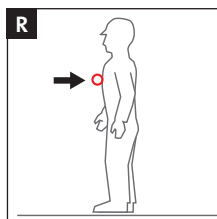

S When climbing, allow the ROPSTOPO3 to move smoothly on the rope.

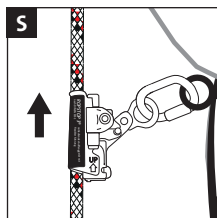

CAUTION: RISK TO LIFE!



Ensure that the fall arrester also moves smoothly during climbing and that there is no slack rope. It may be advisable here to allow the rope to coil downwards. Slack rope extends the fall path.

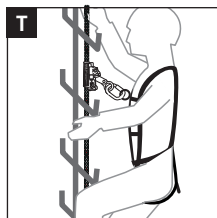

CAUTION: RISK TO LIFE!



Do not guide the fall arrester manually during ascent and descent. The blocking function may be hindered if the device is held during a fall.

T To position the ROPSTOPO3 on the vertical guide rope manually, push up as high as possible. It should be just within reach for adjustment,

ROPSTOPO3 IN USE

U When descending, slightly lift the attachment strap of the fall arrester to release the block, then descend slowly and evenly.

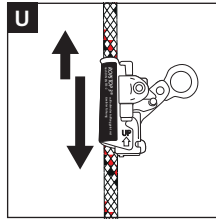

V Ensure adequate clearance below the user to prevent impact on a protruding object or the ground.

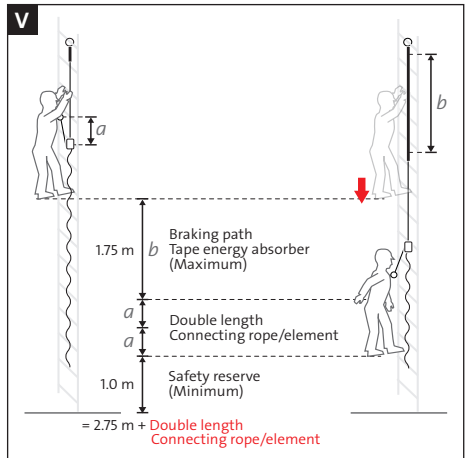

ATTENTION:  Select an anchor point above the ascent to prevent swinging falls.

CAUTION: RISK TO LIFE!  The length a of the connector between the securing D-ring and the fall arrester must be calculated into the required space (twice)!

Example values:
 • for ROPSTOPO3 with a tape energy absorber on the safety rope (page 4 right) and use of the recommended karabiner D SUPERSTRONG with TWISTLOCK PLUS fastener between the D-ring and the fall arrester (fig. W): $a = 0.2 \text{ m}$

ATTENTION:  When starting to ascend near the ground, it is possible, under unfavourable circumstances, that the legs will hit the ground when the fall is arrested.

CAUTION: RISK TO LIFE!  Only one person may be secured at a time on each securing system ROPSTOPO3.

CAUTION: RISK TO LIFE!  The conditions of wet or frozen areas may vary! There is little to no braking effect on wet or frozen ropes!

ROPSTOP03 IN USE

COMBINATION

When combining this product with other parts, there is a risk of mutual impairment with respect to the function and safety. Compatibility must be assessed during the risk analysis. Only combine with personal protective equipment that bears a CE symbol. If you have any questions about compatibility or you require help with the risk analyses, feel free to contact BORNACK.

SAFETY REGULATIONS

There is a risk to life if these safety instructions are not observed!

- CAUTION: RISK TO LIFE! It is prohibited to stand under suspended loads! Wear a safety helmet!
- CAUTION: RISK OF FALLING! After reaching the exit area: Hook in the secondary lock before detaching.
- The personal protective equipment (PPE) may no longer be used even in the case of very minor faults.
- Damaged, fall-stressed, dubious personal protective equipment or safety devices must be immediately withdrawn and not used. The equipment may only be inspected by an expert in compliance with DGUV principle 312-906 and/or a workshop authorised in writing by BORNACK. This must be documented in the test card.
- Independent modifications or repairs are not allowed.
- Rope protection is part of the personal fall prevention equipment and should be assigned to a specific person.
- The personal protective equipment may only be used by qualified staff that are familiar with the material. They must be proficient in handling the personal protective equipment and must have been briefed about the possible risks associated with its use.
- In accordance with the accident prevention guidelines (UVV), the users of personal protective equipment against falls (Category III) must attend a theoretical training course and a practical training course. Make use of the training competence of the BORNACK training centres: info@bornack.de
- Accessories from other manufacturers may only be used if approved by BORNACK and may not impair the function and safety of the protective equipment.
- Clothing and shoes must be suitable for the task at hand and the weather conditions.
- Only use if fully fit and healthy.
- Health impairments can jeopardise the safety of the user when working at heights or depths.
- This PPE has been tested and approved for edge loads. However, extreme loads are always a risk factor. BORNACK recommends using edge protection collars.
- If this PPE is used as an arrester system (free fall is possible), only full body harnesses that comply with EN 361 may be used.
- Calculation of the possible fall path if all necessary PPE components are used correctly: (if necessary braking path HSG) + surplus lanyard (situation-dependent) + braking path energy absorber (max. 1.75 m) + height of D-ring (1.5 m) + safety reserve 1.0 m.
- Calculation of the possible fall path when climbing, if all necessary PPE components are used correctly without slack rope: braking path tape energy absorber (max. 1.75 m) + double length of the connector (e.g. 2 x 0.55 m = 1.1 m) + safety reserve 1.0 m.
- Before use, ensure adequate clearance below the user to prevent impact on a protruding object or the ground.
- Protect personal protective equipment during storing, use and transportation against the effects of heat (e.g. welding flames or sparks, burning cigarettes) and chemicals (e.g. acids, alkalis, oils) and mechanical impact (e.g. sharp edges).

SAFETY REGULATIONS

- The combinability and protective effect of the PPE must be checked for each hazard situation (risk assessment).
- If a casualty hangs motionless in a full body harness for a longer time, blood cannot flow back from the legs and/or the flow may be interrupted. This can lead to a suspension trauma, a circulatory shock with serious to fatal consequences.
- Before starting work, the responsible person must draw up a plan of rescue measures that defines how to rescue casualties quickly and safely and ensures first aid measures. Casualties must be rescued within 20 minutes. BORNACK can help you draw up tailor-made rescue concepts and includes these in the necessary training courses.
E-mail hotline: info@bornack.de
- The local safety guidelines (e.g. in Germany, the DGUV Regulations 112-198 and 112-199 issued by the professional associations) and the accident prevention guidelines for the specific industry (UVV) must be observed.
- Icy or heavily soiled ropes can prevent the blocking mechanism from functioning properly. Maintain and clean the ropes on a regular basis.
- The securing device and the respective rope must be tested and certified as one unit. No other ropes may be used.
- Check the compatibility of the ropes approved for the application!

OTHER

APPROVAL:

Complies with the Regulation (EU) 2016/425 for PPE.

EU type testing (Module B) and production monitoring (Module C2) by:

DEKRA Testing and Certification GmbH
Dinnendahlstr. 9, D-44809 Bochum
CE 0158

Quality management system certified to DIN EN ISO 9001:2015.

Production monitoring by notified office in accordance with Category III.

REGULAR INSPECTIONS

- This personal protective equipment must be inspected at least once a year by an expert in compliance with DGUV Principle 312-906. The result must be documented in the test card at the end of this User Manual.

SALES

- The dealer must ensure that the User Manual is supplied in the language of the designated country. The respective translation must be authorised by BORNACK.

SERVICE

If you have any further questions about this PPE or other BORNACK services, such as:

- Risk analyses
- Rescue concepts
- Training courses
- Expert inspections
- Technical inspections
- Maintenance + inspections

please contact our e-mail hotline:
info@bornack.de

We will be happy to help!

MAINTENANCE

- If necessary, apply a small amount of oil on the joints so that the moving parts of the karabiner and other devices run smoothly. If possible, use precision mechanics oil. Ensure that the oil does not come into contact with textile PPE components.
- Maintenance may only be carried out by a qualified expert in compliance with DGUV Principle 312-906. All instructions in this User Manual must be strictly observed.
- Protective equipment that is clean and well looked after will last longer!

OTHER

CLEANING

- Dry damp personal protective equipment in the air, not on artificial heat sources. Dry metal components with cloths.
- Clean soiled textile components (e.g. arrester harnesses and ropes) with lukewarm water and a little detergent for delicates. Then rinse carefully and allow to dry in the air. Other cleaning agents are not allowed!
- If disinfection is necessary, please contact the e-mail hotline:
info@bornack.de
- If the personal protective equipment comes into contact with salt-water, keep it wet until it can be rinsed with plenty of distilled water.
- Use non-oily compressed air to blow on the unit if necessary.

LIFE SPAN

The following recommendation applies for the use of the ROPSTOPO₃:

Maximum usage period after being used for the first time: 10 years

In ideal storage conditions and annual inspections, the product may be stored for up to 3 more years before it is used for the first time without impacting on the stated maximum usage period. Every further year in storage reduces the final maximum allowed usage period by 1 year.

Metal parts are not subject to age-related life span deadlines. The expert makes a decision about these parts based on his technical expertise.

For reasons of safety, intensive use and/or extreme application conditions such as sharp edges, chemical influences, UV radiation etc. will reduce the usage period. The company owner needs to take this into account in the workplace risk analysis.

The company owner must ensure compliance with the maximum usage period by documenting first-time use in the test card.

The test card at the end of this User Manual must be presented during the regular expert inspections and be completed by an expert.

For more details, please visit www.bornack.de.

REPAIRS

- For reasons of liability, repairs may only be carried out by the manufacturer.
- Only original spare parts from the manufacturer may be used.

OTHER

STORAGE

- Dry wet PPE **before** storage.
- Store in a dry place away from direct sunlight.
- Do not store PPE near radiators. Permanent exposure to temperatures below 0 °C or above +50 °C has a negative impact on the strength of the textile material and shortens the life span.
- Do not allow PPE to come into contact with aggressive substances (e.g. oils, grease, acids, chemicals). Precision mechanics oils may be applied to moving metallic parts during maintenance. Always ensure that textile PPE components do not come into contact with the oil.
- Do not store personal protective equipment close to aggressive substances (see above) because even the vapours of aggressive substances can have a negative effect on the strength of the PPE.
- Protected storage in the device case or device bag.

TRANSPORT

- Protected transport in the device case or device bag.

OTHER

PRODUCT IDENTIFICATION

The following identification is on the product:

Fall arrester/right side

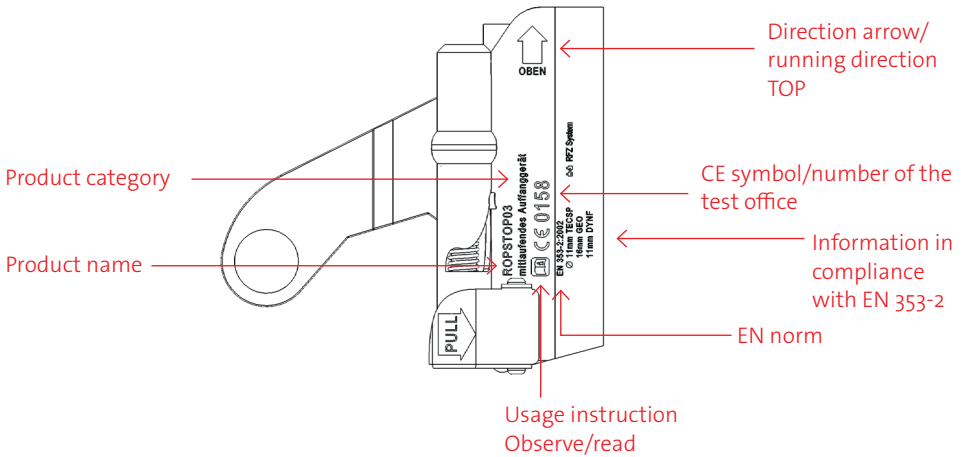

Fall arrester/left side

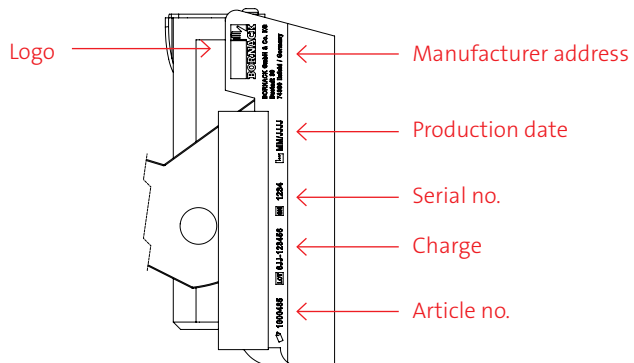

OTHER

Safety rope:

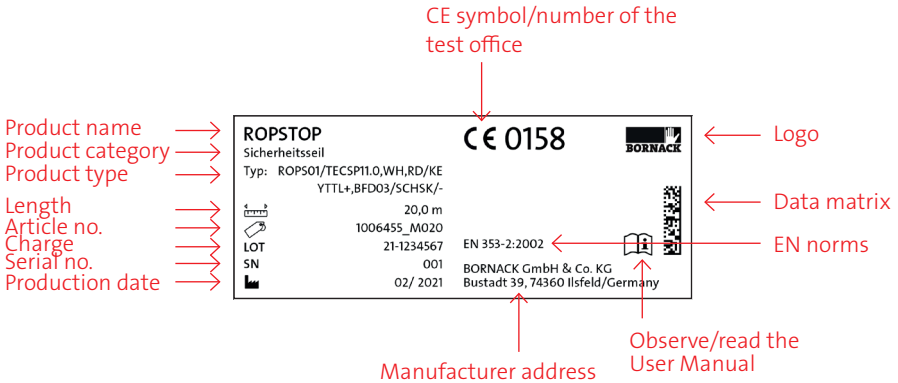

Tape energy absorber:

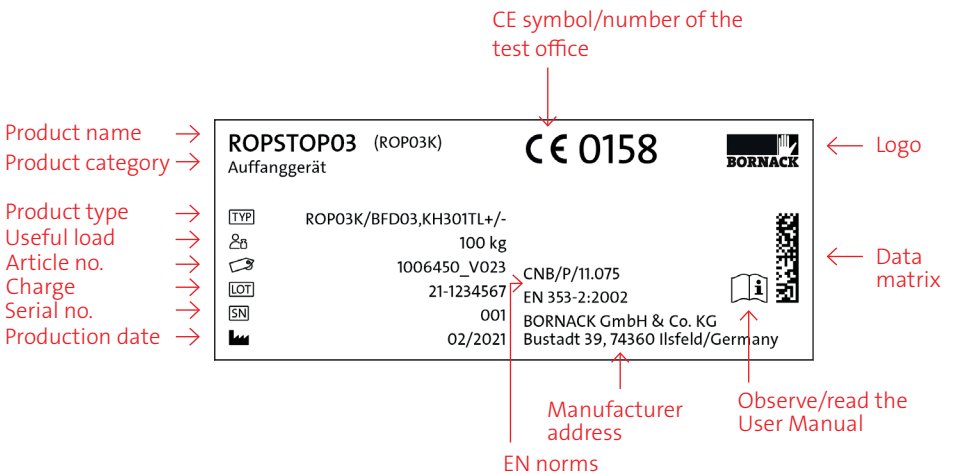

EU DECLARATION OF CONFORMITY



EU Declaration of Conformity

The manufacturer or his authorised representative established within the EU

BORNACK GmbH & Co. KG
Bustadt 39
74360 Ilsfeld
Germany

hereby declares that the following personal protective equipment

Guided type fall arrester including a flexible anchor line
ROPSTOP03

- is in conformity with the relevant harmonisation legislation according to Annex V (Module B) of the Regulation (EU) 2016/425 on personal protective equipment according to Article 19 (category III PPE) and is examined to EN 353-2:2002 CNB/P/11.075 (ROPSTOP03 Typ: ROP03K only)
- is identical to the PPE that is the object of the **EU type-examination certificates**
No. ZP/B027/21 ZP/B028/21

issued by

DEKRA Testing and Certification GmbH
Dinnendahlstraße 9
44809 Bochum
Germany
CE 0158

- is subject to the assessment of conformity to type, based on internal production control plus supervised product checks according to Module C2 of the Regulation (EU) 2016/425 for personal protective equipment (category III PPE), monitored by the notified body

DEKRA Testing and Certification GmbH
Dinnendahlstraße 9
44809 Bochum
Germany
CE 0158

16 July 2021

BORNACK GmbH & Co. KG

A handwritten signature in blue ink that reads 'U. Bornack'.

Ulrike Bornack
Managing Director



TEST CARD

FOR ANNUAL MONITORING

The test list must be completed in full by the expert during the annual inspection.

Type ROPSTOPO3: _____

Production date: _____

Charge No.: _____ Serial No.: _____

This test list does not claim to cover all test criteria and does not relieve the expert from his decision about the overall condition.

Purchase date: _____

Date of first Use: _____

Maximum life span until: _____

	Date	Signature	Next inspection	Reason for inspection
Year 1				
Year 2				
Year 3				
Year 4				
Year 5				
Year 6				
Year 7				
Year 8				
Year 9				
Year 10				

TEST CARD

FOR ANNUAL MONITORING

Please complete:

	Year 1	Year 2	Year 3	Year 4	Year 5	Year 6	Year 7	Year 8	Year 9	Year 10
All components in place?										
Safety rope undamaged?										
Seams undamaged?										
Rope end connections undamaged?										
No mechanical damage?										
No chemical soiling?										
No deformation of metal parts?										
No corrosion damage?										
Tape energy absorber undamaged?										
Tape energy absorber sleeve undamaged?										
Karabiners in place & fully functional?										
Condition of the springs/ rivets/axles OK?										
Locking mechanism functional?										

Continued on the next page



FALLSTOP

Safety equipment for securing and rescuing at heights and depths

SAFEPOINT

Planning and assembly of stationary securing systems

BORNACK GmbH & Co. KG

Bustadt 39
74360 Ilsfeld
Germany

Tel + 49 (0) 70 62 / 26 90 0-0
Fax + 49 (0) 70 62 / 26 90 0-550
info@bornack.de
www.bornack.de

